

Data Sheet

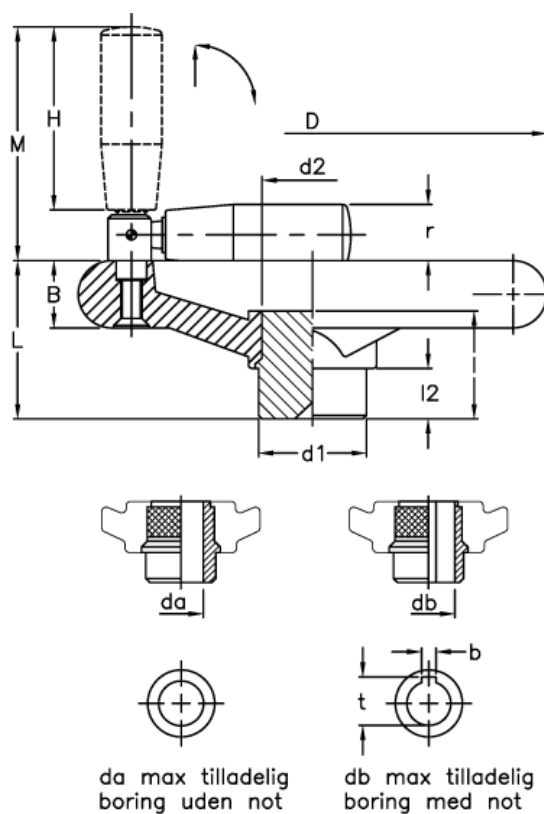

Article number: 2301077531
Description: E+G Handwheel
VR.180 FP+IR

Measures



B	= 24	H	= 80	t = 24.8
b	= 6	l	= 43	
C (N m)	= 280	L	= 56	
D	= 180	L (J)	= 15	
d1	= 40	l2	= 15	
d2	= 31	M	= 100	
da	= 26	r	= 24	
db	= 22	R	= 68	